

RDW-ZW39

座檯式洗碗碟機 Table Top Dishwasher

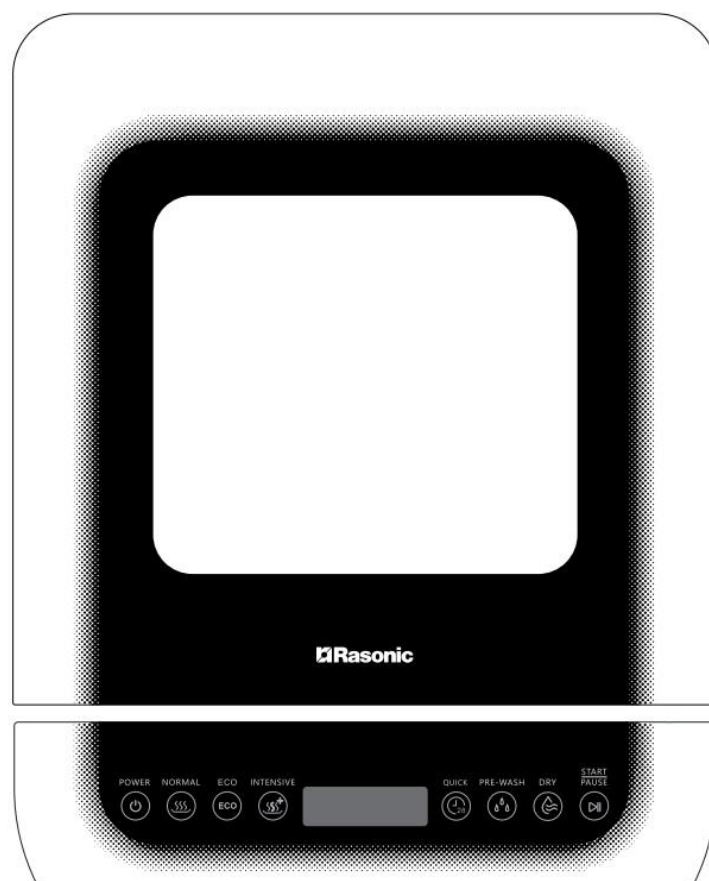

僅適用於家庭使用
For household use only

使用說明書

OPERATION MANUAL

- 在使用本產品前，請仔細閱讀本說明書，並妥善保存本說明書以備用戶日後查詢。
Please read the operation manual carefully before using and well keep it in a safe place for future reference.
- 本說明書中的圖示可能有與實物不同的地方，僅供參考。
Some figures in this manual may not match with the real object, just for reference only.

非常感謝您選購樂信牌座檯式洗碗碟機，在使用前請先詳細閱讀本說明書，並保存以備日後參考。

目錄

1. 安裝注意事項
2. 安全注意事項
3. 安裝方法
4. 清潔及保養
5. 特別注意事項
6. 產品規格
7. 產品說明
8. 使用說明
9. 故障排除
10. 特別聲明
11. 售後服務

1. 安裝注意事項

本產品符合安全要求，不適當使用有可能導致個人傷亡及財物損失。因此，使用本產品時，必須遵守下列安全注意事項：

為了防止火災、灼傷和觸電 使用本產品前

1. 本產品屬高耗電量電器，須使用獨立電源插座，不應與其他電器共用一個電源插座，亦須確保當地的電壓與本產品上所標明的額定電壓相符。
2. 為防止觸電，必須確保本產品已接地良好。
3. 確保電源插頭與插座徹底連接，否則會因接觸不良導致電源線過熱而影響本產品運作，加快本產品損壞或造成火災等危險。
4. 本產品淨重約 13 公斤，用戶應將本產品置於有足夠承托力的平面上使用。此機底部有排氣口，避免置於地毯、塑膠檯布及棉檯布等低耐溫的物料上。
5. 使用時，須確保空氣流通。本產品屬於座檯式型號，切勿安裝於櫃內，避免堵塞本產品的通風排氣孔而造成過熱。切勿在本產品頂部放置任何物件。切勿將金屬物件（如針或金屬線等）插入產品的內部、縫隙或蒸氣出口等位置。
6. 應將本產品放在通風及乾爽的地方，並須遠離腐蝕性氣體、火源、高溫、強磁力、蒸氣、潮濕、油煙或接觸到易燃物的的環境中使用。

2. 安全注意事項

2.1 首次使用注意事項

1. 取出所有包裝物料。如機門上附有保護膜，應將其撕掉。
2. 徹底檢查本產品及配件有否損壞及裂痕，如水箱、機門、噴水臂、上層／下層盛載籃、過濾網等出現損壞，切勿安裝及使用本產品。
3. 產品於出廠前均會進行多次測試，以確保運作正常。部分水氣和水漬或會殘留於水箱內或機身，可用扭乾的濕布擦拭。

2.2 使用後，請切斷電器的電源

1. 切斷本產品的電源及拔出電源插頭，避免因長時間通電導致內部電子組件損毀（老化），繼而引起火警。
2. 注意保持清潔，做好防塵、防潮的保護，並避免蟑螂等昆蟲進入水箱及蒸氣出口而造成電路板短路。

2.3 重要安全指示

1. 切勿於水箱注入 40°C 或以上的熱水，以免損壞本產品。
2. 必須使用洗碗機專用洗碗粉，切勿使用液態清潔劑、肥皂、洗衣粉或洗手液等容易起泡的洗滌劑來替代，否則造成機器故障，甚至發生危險。儲存此類洗碗粉時，須放置於兒童無法接觸的地方。讓兒童遠離洗碗粉！洗碗粉可能會導致口腔、咽喉和眼睛的化學灼傷或窒息。如洗碗粉不慎濺入眼睛，應立即以大量清水沖洗，並須迅速就醫。
3. 時刻保持機門關閉。只有在機門完全關上後，才可操作本產品。洗滌時切勿打開機門，熱水有可能會噴出，亦不要將手或面部靠近造成燙傷。
4. 為減低受傷風險，切勿讓兒童在本產品內部或上方玩耍，因為機器可能還有殘留的洗碗粉。
5. 機門開啟時，切勿放置重物或站立於機門、機頂或盛載籃上，否則可能導致產品向前傾倒。
6. 切勿將任何溶劑放入洗碗碟機內，有可能造成爆炸等危險。
7. 避免使用鋒利的器具刮傷門邊密封膠邊或機體，以免造成機身破裂及漏水，導致觸電。
8. 如發現機門不能緊閉、變形或門組件損壞，為避免危險應立即停止使用，並聯絡信興電器服務中心有限公司進行檢查及維修。
9. 切勿在機身與機門之間放置任何物品，或讓灰塵、殘餘的洗碗粉積存於門縫表面。

2.4 操作注意事項

1. 經常清潔產品的噴水臂及過濾網，以免影響噴水臂的轉動及清洗效果。如噴水臂轉動不順暢或清洗效果不佳，立即檢查噴水臂及過濾網是否安裝妥當。建議拆除噴水臂及過濾網，並檢查內腔的噴水孔、排水台是否有異物堵塞。如有堵塞應即時清除，並裝好所有配件並選用<<預洗>>功能 (PRE-WASH) 清洗空機。
2. 為防止滿溢，注水切勿太快！為防止注入過多水量引致水從注水口溢出，部份水會預先注水入內腔，此乃正常情況。**注意！**注水過多會令排水台滿溢，導致漏水。
3. 產品運作時，切勿注水入水箱，否則會導致機內注水過多，引致漏水情況。
4. 使用本產品前，應確保所有配件（包括噴水臂、過濾網及排水管等）都已完全安裝穩妥。否則，清洗過程或會因水壓過強而引致漏水情況。
5. 不建議清洗刀具或其他尖銳器具；如要清洗（如銳利刀具）必須妥善放置，以免刀具損壞機門密封膠邊並減低割傷風險。**警告！**刀或其他尖銳的物品請小心放入盛載籃，並且尖端朝機內水平放置，以避免拿取時受傷。
6. 切勿洗滌塑膠餐具，除非餐具表明「可用於洗碗碟機清洗」；如未有標示，請查看製造商建議事項。
7. 切勿敲打或亂按控制面板，否則會引致錯誤操作及破壞控制器。
8. 如碗碟放置過多，取物時或會有前傾的危險。建議按**章節 6. 產品規格**的可裝載餐具數量使用本產品。
9. 切勿將易燃物置於機頂或機內，以免導致起火。在配件沒有完全安裝好的情況下，切勿使用本產品。
10. 切勿使用外置計時器或遙控系統來操作本產品。
11. 本產品運作時或使用後，外殼及內腔或會變得灼熱。切勿接觸以免燙傷。
12. 開啟機門時請注意力度，避免令機內的碗碟弄翻，以免造成危險。

13. 切勿將本產品用於清洗餐具以外的其他用途：如用作存放用途或利用本產品烘乾布類、報紙或其他東西等。(如本產品用於清洗其他物件，則有可能發生故障。)
14. 切勿將機身、電源線或插頭浸入水中或用水淋洗，以免影響產品的安全性能及防止造成觸電的危險。
15. 小心使用電源線，不可在電源線上放重物或夾住電源線；不可改裝電源線；切勿用力拉扯或扭曲電線；在拔出或插入插頭時，要用手握穩插頭本身。切勿將電源線懸掛在桌子、櫥櫃的邊緣或令其接觸發熱的表面。
16. 使用後或長期不使用時，應將插頭從插座內拔出，以免因絕緣老化而發生漏電及觸電危險。切勿使用濕手接觸、插入或拔出插頭，以免觸電。
17. 移動、檢查或清潔本產品前，應先拔掉電源線插頭，待本產品冷卻後再進行。
18. 本產品只可作家庭使用，切勿在室外使用或用作說明書建議以外的其他用途。如不當使用，或作為(半)商業用途，維修保養將無效，本公司將不會承擔任何損壞的維修責任及賠償。
19. 切勿讓嬰兒靠近。若有孩童在旁，須加倍小心使用及看管小孩，以確保他們不會把此產品當作玩具。切勿讓小孩單獨使用，亦切勿將本產品放於小孩能觸及的地方。
20. 本產品可供年齡在 8 歲或以上的兒童及體質、感覺或智力有障礙人士或缺乏經驗和相關知識的人士使用，但他們必須接受負責安全人士的監督或指導如何安全地使用產品和理解所涉及的危險。
21. 本產品適合於家用或在類似環境使用，如：商店內部、辦事處以及其他工作環境的員工廚房區域；旅館、汽車旅館和其他住宿類型的環境。切勿於戶外使用。
22. 經常檢查本產品的電源線、插頭、機門、噴水臂、過濾網及盛載籃等是否有破損，或曾經有跌落；如有懷疑，為避免危險應立即停止使用，並聯絡信興電器服務中心有限公司作檢查及維修。
23. 切勿擅自改裝產品或使用非生產商提供的配件或零件進行修理，否則會造成危險及維修保養無效。
24. 遵從安全守則及避免釀成意外，如需維修電器，請聯絡信興電器服務中心有限公司（地址印於本使用說明書的背頁或致電 2406 5666 查詢），並確保在檢查或維修時出示保修登記卡及收據。

3. 安裝方法

注意！請按指示小心安裝本產品，若沒有按照本說明書安裝、試機、檢查而出現損壞，本公司概不負責。

本產品提供手動進水或連接進水管 (固定進水) 兩種方式為產品提供水源：手動進水可直接於機頂注水口倒入所需的水量；如採用連接進水管方式，應注意以下要點：

- 安裝完成後，必須試行運作，待檢查妥當後才可使用。
- 切勿使用舊進水管，以免運作時漏水。
- 產品於出廠前曾進行測試；如發現包裝物料有水滴殘留，此乃正常情況。
- 本產品適用的進水壓力介乎 0.04 MPa – 1.0 MPa，須確保使用地點的水壓於適用範圍。當水壓較低時，運作時間或會延長。如有需要，可於安裝前向專業人員瞭解。

採用連接進水管 (固定進水) 方式的客戶，可按照以下步驟進行安裝：

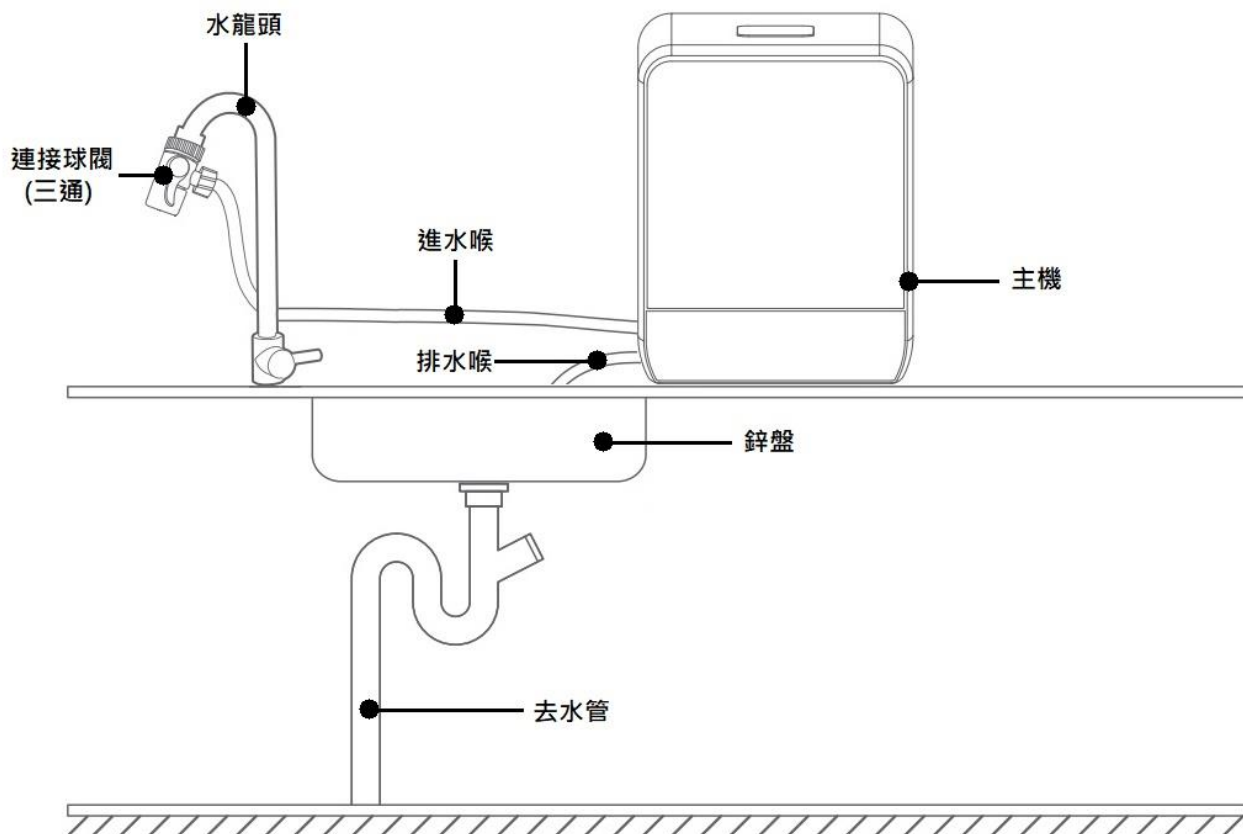

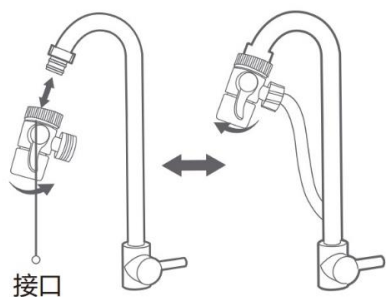

1. 關閉水源
 - 必須確認入水掣已完全關閉。
2. 安裝連接球閥 (三通)、進水喉及排水喉

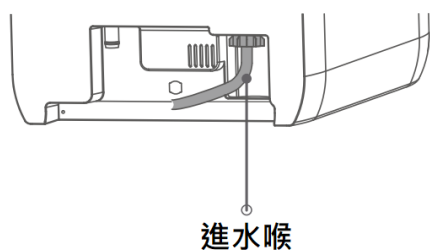

- 如上圖所示，先將三通逆時針方向旋緊至水龍頭，然後將入水喉〔不帶彎頭的一端〕旋緊至三通閥的四分出口螺紋上，三通安裝已完成；如需拆卸，必須先關閉水龍頭開關，然後拆除進水管，再將三通順時針旋轉以拆卸。

3. 安裝進水喉



- 如上圖所示，將入水喉〔帶彎頭的一端〕旋緊至機背的進水口。
- 安裝完成後，水龍頭模式將會啟動，水龍頭指示燈“”會亮起，產品會於選定清洗模式後，直接於水龍頭取水。

4. 安裝排水喉

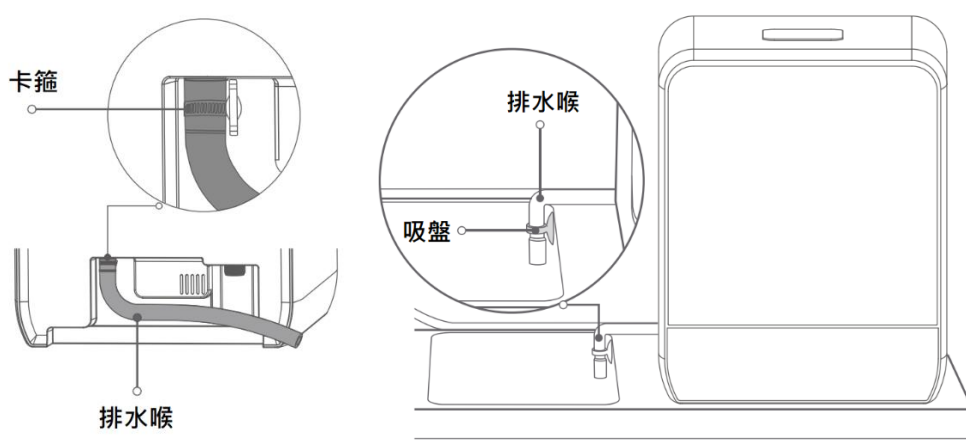

- 將排水管〔帶彎頭一端〕套入機背的出水口位置，並用卡箍固定；另一端排口喉則連接至鋅盤上，並用吸盤固定。

4. 清潔及保養

定期檢查及保養可以避免機器故障，建議用戶按以下各項定期檢查本產品：

1. 產品的整體狀況

檢查噴水臂及產品內腔是否積聚油脂及水垢沉積物；如發現有沉積物，請加入洗碗粉並選用<<預洗>>功能 (PRE-WASH) 清洗空機。

2. 清潔機門的密封膠邊

定期以濕布清潔機門的密封膠邊。切勿使用蒸氣清潔機清潔，本公司對任何因使用蒸氣清潔機所造成的損壞，恕不負責。

定期以濕布清潔產品的機門及控制面板。切勿使用粗糙潔具或含腐蝕性的清潔劑進行抹拭，否則過程中可能會刮傷產品表面。

3. 過濾系統

過濾系統包括粗過濾網、幼過濾網及平面過濾網。過濾系統是為了阻隔較大的食物殘渣進入產品的水泵循環系統中，必須定期清理，否則殘渣可能會造成堵塞，影響本產品操作。

每次使用後，將過濾網囤積的食物殘渣清除。先以逆時針方向轉動將圓筒形過濾網取出，再取出平面過濾網。清除堆積物及用清水沖洗乾淨後，放入平面過濾網，然後以順時針方向轉緊圓柱型濾網，並確認上面的箭頭符號是否已對齊。

4. 噴水臂

水垢及食物殘渣有可能阻塞噴水臂，繼而影響噴水臂旋動，用戶必須時刻檢查，必要時可將噴水臂取出清潔。用清水沖洗即可，完成後，將上及下噴水臂裝回內腔對應位置上。(詳情可參考**章節 7.2 操作說明**)

5. 排水泵

無法被過濾而留在排水台的食物殘渣有可能堵塞排水泵，令水無法排走而造成堵塞或滿溢。如出現以上情況，先關掉電源並拔出插頭，取出所有過濾網，盡量將水舀出，或用海綿將水吸走及同時清除食物殘渣。完成後，再重新安裝過濾網，才可繼續使用。

6. 進水口

產品於機頂及機背位置均設置進水口，為客戶提供手動進水或連接進水管 (固定進水) 兩個渠道為產品提供水源；每個進水口均設有過濾網，為水源進行過濾。為免產品的進水口受阻而影響產品運作，請確保定時為進水過濾網進行清潔。

餐具準備事宜

1. 烤焗、蒸蛋或蒸肉後，若出現燒焦痕跡或蛋白黏附於器皿上，必須事先浸泡及清理，否則可能無法徹底清洗。
2. 如器皿上殘留明顯食物殘渣或以下殘渣，必須事先清除：
 - A. 調味料、香料及芝麻等細小食物殘渣；
 - B. 牙簽、魚骨及橡筋等可能妨礙噴水臂轉動之異物；
 - C. 可能引起異味的殘渣：如魚皮及蒜頭等。
3. 如器皿上殘留較多油份或含食物色素的醬汁，建議事先用水沖洗，否則油份及色素有可能沾染機身內部。
4. 如器皿沾染食物色素、茶漬或唇膏漬，或無法徹底清除。

一般清潔注意事宜

1. 切勿使用含氯清潔劑，或有損健康。
2. 清潔前，必先關掉本產品，並拔掉電源插頭及待其冷卻。
3. 保持產品內外表面及機門清潔。可用沾有中性清潔劑的軟綿布或海綿擦拭，並用沾有清水的布抹淨。避免使用硬刷子或粗糙的潔具洗刷，以免損壞本產品內外表面及機門玻璃的保護層。(注意！清潔時，切勿讓水滲入縫隙或蒸氣出口。)

4. 如控制面板被弄濕，應用乾的軟布抹擦，切勿使用粗糙及磨損性的潔具來抹擦控制面板。抹擦控制面板時，先將機門打開，以免錯誤運作。
5. 切勿使用有毒或含腐蝕性清潔劑進行清潔。
6. 零件清洗完畢後，必須完全擦乾後才裝回本產品。
7. 如需存放，必須待本產品完全冷卻及清洗後才能儲存。應放入紙箱並放置於乾爽環境中。
8. 切勿將電源線纏繞在本產品四周或壓住電源線，避免造成電源線磨損和破裂。

5. 特別注意事項

使用前，必須檢查清楚所有器皿是否適合用本產品清洗。以下物料的餐具或器皿均不適合利用本產品清洗：

1. 木製餐具或器皿；
2. 精緻的玻璃裝飾、工藝品和古董器皿等；
3. 塑膠器皿 (除非器皿標明“洗碗碟機適用”，否則，用戶須向器皿製造商查詢)；
4. 銅及錫製器皿；
5. 染有灰、蠟、潤滑油或油墨漬等器皿；
6. 鋁和銀製器皿 (多次循環清洗後，或會出現變色或褪色等情況)；
7. 玻璃類器皿 (例如水晶玻璃等) (多次循環清洗後，或有可能變得渾濁)；
8. 易潔塗層器皿 (除非器皿標明“洗碗機適用”，否則，用戶須向器皿製造商查詢)。

6. 產品規格

型號	RDW-ZW39	
顏色	白色	
額定電壓	220 - 240 伏特~ 50 赫茲	
額定水壓 (只適用於固定進水安裝)	0.04 MPa - 1.0 MPa	
額定功率	950 - 1,050 瓦	
水箱容量 (約)	5 公升	
淨重 (約)	12.8 公斤	
產品尺寸 (闊 x 深 x 高) (約)	370 x 510 x 452 毫米	
建議可裝載餐具數量及尺寸	4.6 吋飯碗 x 6 隻 6 吋湯碗 x 2 隻 8 吋碟 x 6 隻 醬油碟 x 3 隻	玻璃/馬克杯 x 5 隻 湯/飯勺 x 2 隻 湯匙 x 6 隻 筷子 x 6 對

7. 產品說明

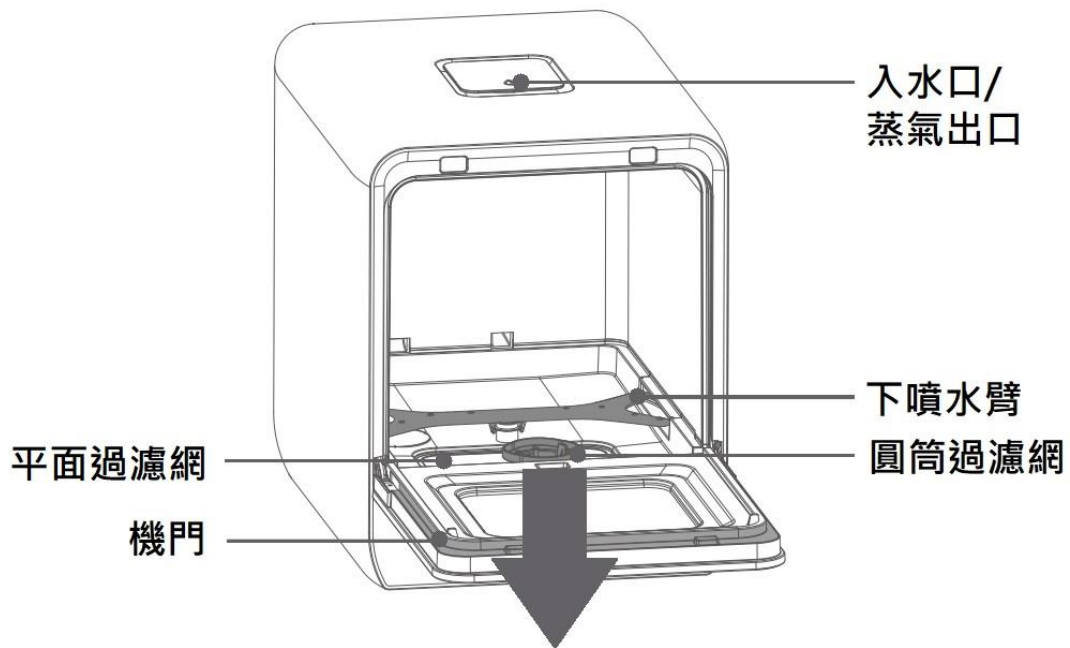

粗過濾網



幼過濾網

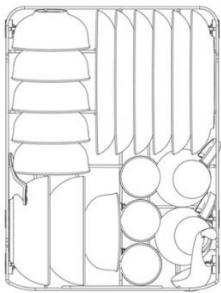

下層載物籃

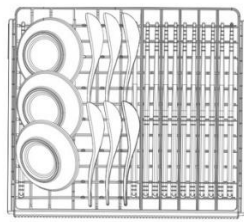

上層載物籃



卡箍



連接球閥 (三通)



吸盤



排水喉



進水喉



量杯

7.1 控制面板及顯示屏

控制面板

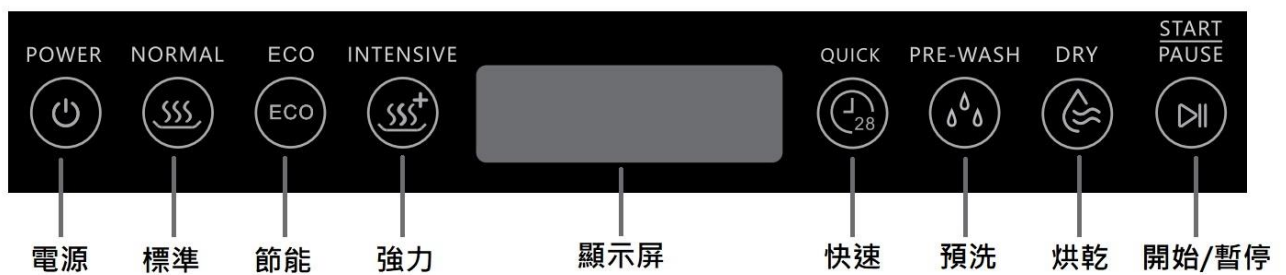



7.2 操作說明（適用於手動注水）

注意！ 安裝前，確保本產品未有接駁電源。

1. 參考**章節 3. 安裝方法**連接排水喉至鋅盤，並利用吸盤固定出水喉，以免污水溢出。**注意！**切勿將排水喉朝上安裝以至高於機底 15 厘米的位置，及保持鋅盤排水口暢通，切勿浸入水中，否則污水將會倒流入機體內。

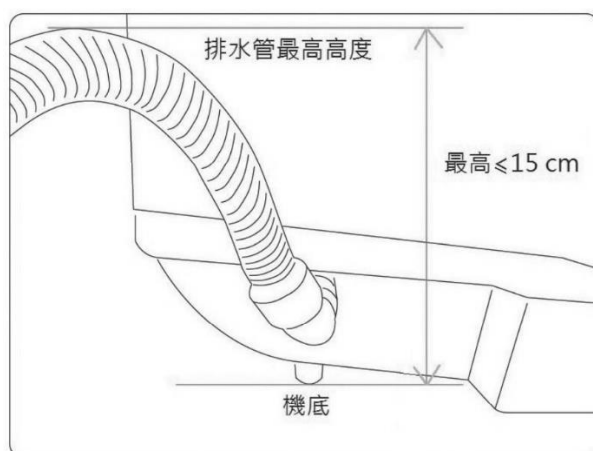

2. 將機內配件等全部取出，按次序將平面過濾網及圓筒形過濾網（由粗過濾網及幼過濾網組成）順序裝入。順時針轉動圓筒形過濾網作鎖定。
3. 噴水臂安裝：用手握住噴水臂的中間位置，對準機內底座噴水孔，用力按下直至聽到“咔嚓”聲響。用手轉動噴水臂，以確保噴水臂安裝妥當及順暢旋轉。〔備註：**不建議**自行拆除上噴水臂，以免影響產品工作〕
4. 先將餐具食物殘渣及醬料清理（可於水龍頭下稍作沖洗或用抹手紙擦淨），拉出盛載籃，然後將餐具按指示（可參考**章節 7.3 盛載籃裝載示意圖**）放到盛載籃指定位置上。
5. 將盛載籃推入機內，將洗碗粉放入門背的洗碗粉格內（最大容量為 8 克），然後關上機門。
6. 接通電源，產品進入待機狀態。利用隨機的量杯於入水口注入約 2.5 杯水，直至聽到“滴滴”聲音提示，表示水箱已注滿水。

*** **注意！** 在任何情況下，切勿擅自拆除入水口的圓型過濾網。

*** 請於機頂上方預留足夠位置，方便注水。

- *** 如用戶未能於 2 分鐘內完成手動注水程序，產品會返回待機狀態。用戶須長按【電源】鍵 3 秒重新開啟產品。
- *** 如使用固定進水安裝方法，可忽略此步驟。固定進水安裝後，水龍頭模式啟動，產品會於選定清洗功能後自動注水，詳細安裝資料可參考**章節 3.安裝方法**。

7. 長按【電源】鍵 3 秒啟動產品後，選擇所需的清洗功能，按【開始/暫停】鍵確認，產品會開始運作。如確認後需變更清洗功能，可長按【電源】鍵 3 秒返回待機狀態，然後重新啟動產品後選擇合適功能。
8. 洗滌完成後，建議即時清洗濾網及去除食物殘渣，以防細菌滋生。（如發現難以去除的污垢，可用軟刷協助清理；切勿使用鋼絲刷或百潔布等，否則過濾網會因此而損壞。）
9. 本產品備有通風換氣功能，於洗滌完成後會自動運作，烘乾指示燈“☼”會亮起。若要取消通風換氣功能，可長按【電源】鍵 3 秒關機並拔除電源插頭。

7.3 盛載籃裝載示意圖

參考下圖，將所有餐具放置在上層及下層盛載籃的預定位置上，筷子及湯匙等必須放置於上層盛載籃內。（如有尖銳餐具，尖端須向內及小心放入，以免割傷。）

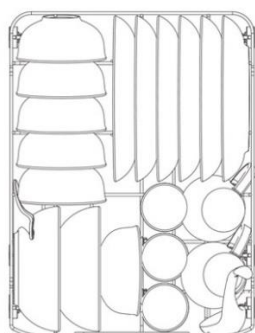

下層載物籃

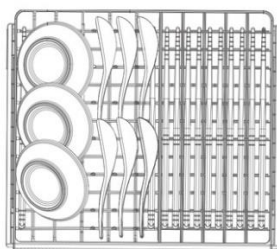

上層載物籃

餐具方面，開面口應該向下斜放，切勿將餐具開口向上或餐具底向上。

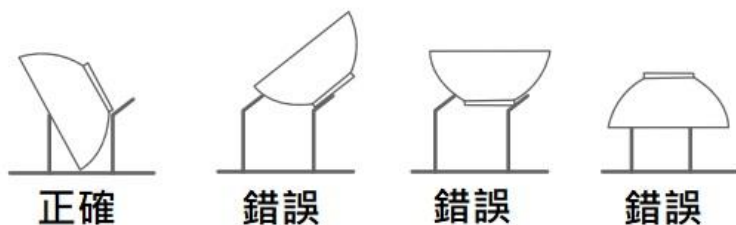

警告！刀和其他鋒利的用具必須裝在上層盛載籃裏，並且尖端朝內水平向內放置。

為避免在操作過程中發出噪音，避免堆疊碗碟。較輕的餐具必須穩固地置於盛載籃中。

注意！開始啟動操作前，請確保碗碟、筷子、叉等餐具已穩固地放在籃中，如有任何餐具穿過盛載籃，將會影響噴水臂的運作，令產品無法操作。

8. 使用說明

接通電源，所有指示燈閃動一次，產品進入待機狀態。

1. 開機：待機狀態下，長按【電源】鍵 3 秒啟動產品。如 2 分鐘內沒有選取任何清洗功能，產品會自動返回待機狀態。
2. 選擇應用程式：在啟動產品後，按功能鍵選擇所需應用程式，再按【開始/暫停】鍵一次，產品會自動啟動有關功能程式。具體運作程式如下：

功能	圖示	洗滌時間 (約) [^]	烘乾時間 (約)	通氣換氣功能	備註
標準洗# (NORMAL)		58 分鐘	60 分鐘	自動	建議加入約 8 克 洗碗粉
節能洗 (ECO)		88 分鐘	60 分鐘	手動 (如須啟動，可於 清洗過程中，按 【烘乾】鍵一次 開啟)	建議加入約 8 克 洗碗粉
強力洗# (INTENSIVE)		78 分鐘	60 分鐘	自動	建議加入約 8 克 洗碗粉
特強洗*#	/	98 分鐘	60 分鐘	自動	建議加入約 8 克 洗碗粉
快速洗 (QUICK)		28 分鐘	60 分鐘	自動	建議加入約 8 克 洗碗粉
預洗 (PRE-WASH)		19 分鐘	不適用	不適用	<u>無須</u> 加入洗碗粉
烘乾 (DRY)		不適用	60 分鐘	自動	<u>無須</u> 加入洗碗粉

[^]備註 1：洗滌時間並不包括進水時間和排水時間，故實際完成時間會比洗滌時間長。亦因應不同的使用條件〔如注水溫度等〕，整體操作時間會略有不同，上述時間只供參考。

*備註 2：如需選擇<<特強洗>>功能，可長按【強力洗】鍵 3 秒，顯示屏會顯示“1:38”(98 分鐘)，即表示特強洗清洗模式已選擇。

#備註 3：針對<<標準洗>>(NORMAL)、<<強力洗>>(INTENSIVE)及<<特強洗>>功能，水龍頭模式(固定進水)會比水箱模式(手動進水)多一次過水程序，但整體運作時間不變。

3. 暫停功能：運作過程中，如用戶需要暫停操作，可按【開始/暫停】鍵一次暫停運作。如須恢復運作，再按【開始/暫停】鍵一次，產品會重新開始工作。
4. 通風換氣模式：完成清洗功能後，產品會自動啟動通風換氣模式 (<<節能洗>>功能 (ECO) 需要**手動開啟**此功能)，以確保機內及餐具乾爽，防止產生異味。通風換氣運作時間為 3 天，顯示屏會顯示“72H”(72 小時)，並會以倒數形式顯示剩餘時間。如須取消，長按【電源】鍵 3 秒返回待機狀態。
5. 特長通風換氣功能：按實際需要，可啟動特長通風換氣功能。用戶可於清洗過程中，按【烘乾】鍵一次，顯示屏顯示“7d”(7 天) 表示特長通風換氣功能已開啟。特長通風換氣運作時間為 7 天，並會以倒數形式顯示剩餘時間。如須取消，再按【烘乾】鍵一次，產品會返回“72H”(72 小時) 通風換氣功能。
6. 預約功能 (**不適用**於烘乾功能)：選擇所需應用程式後，長按【烘乾】鍵 5 秒進入預約功能設置，顯示屏顯示預設時間“1H”(1 小時)。重按【烘乾】鍵可選擇預約開始時間 (預約範圍包括 1 小時/ 2 小時/ 3 小時/ 4 小時/ 5 小時/ 6 小時/ 8 小時/ 10 小時/ 12 小時/ 16 小時/ 20 小時/ 24 小時)。設定後，按【開始/暫停】鍵一次確認。
7. 關機：使用後，應將插頭拔除。

9. 故障排除

使用時，如顯示屏出現故障代碼，在維修前請先對照下表進行檢查。

故障/ 故障代碼	檢查要點	處理方法
內腔、上層載物籃及平面過濾網下仍有殘留水	餐具是否已完全乾透？	如餐具已完全乾透，內腔、上層載物籃及平面過濾網下仍會有少量殘留水，此乃正常現象。
餐具沒有完全乾透	餐具是否擺放不良？	參考“ 章節 7.3 盛載籃裝載示意圖 ”擺放餐具。
餐具不乾淨	洗碗粉是否不足夠？	按需求增加洗碗粉用量。
	餐具是否擺放不良？	參考“ 章節 7.3 盛載籃裝載示意圖 ”擺放餐具。
	過濾網是否堵塞？	參考“ 章節 4 清潔及保養 ”定期清洗過濾網。
	是否選用不正確清洗程序？	按器皿的骯髒程度選擇合適的清洗程序。
機內發出異響/ 碰撞聲	器皿是否與噴臂碰撞？	暫停清洗程序，打開機門檢查器皿擺放情況。
	是否有小物件掉落造成聲響？	將小物件取出，盡量避免使用本產品清洗小物件。

按鍵後沒有反應	機門是否未關妥？	請將機門關好後再選擇功能。
	機門感應器異常	聯絡 信興電器服務中心有限公司 進行檢查及維修。
機內出現大量泡沫	是否添加洗碗粉以外的清潔劑？	請使用洗碗機專用的洗碗粉清洗器具。
洗碗籃染色	器皿脫色	避免將會脫色器皿放入機內清洗，擺放器皿前，請參考“ 章節 5 特別注意事項 ”。
缺水指示燈亮起	水箱是否仍未加水？ (手動注水)	選擇清洗程式前，將足夠水量注入水箱。
	水龍頭是否仍未開啟？ 或水壓是否低於 0.04MPa？ (固定注水)	確保水龍頭已開啟。如水壓低於0.04MPa，請客戶另行購置水泵，為產品供水。
	進水管異常 (固定注水)	請理順進水喉，確保沒有過份彎曲、屈摺或堵塞。
	進水閥異常	聯絡 信興電器服務中心有限公司 進行檢查及維修。
故障代碼	E1 進水異常	確保水龍頭已開啟，重新啟動本產品。如情況持續，聯絡 信興電器服務中心有限公司 進行檢查及維修。
	E2 排水異常	關閉水龍頭，並聯絡 信興電器服務中心有限公司 進行檢查及維修。
	E3 溢出異常	聯絡 信興電器服務中心有限公司 進行檢查及維修。
	E4 水溫感應器異常	聯絡 信興電器服務中心有限公司 進行檢查及維修。
	E5 通訊異常	聯絡 信興電器服務中心有限公司 進行檢查及維修。
	E6 加熱管運作異常	截斷電源及重新啟動本產品。如情況持續，聯絡 信興電器服務中心有限公司 進行檢查及維修。
	E7 散熱風扇運作異常	聯絡 信興電器服務中心有限公司 進行檢查及維修。

如按照以上處理方法仍然無法恢復正常運作，應立即停止使用，並聯絡**信興電器服務中心有限公司**進行檢查及維修。

10. 特別聲明

1. 本資料上所有內容經過核對，如有任何印刷及內容上的誤解，本公司將保留解釋權。
2. 本產品若有技術改進，會編進新版說明書中，恕不另行通知；產品外觀、顏色如有改動，則以製造商資料為準。
3. 如本資料之中英文版本有差異時，應以中文版為準。
4. 使用說明書的電子副本可透過電子郵件發送致客戶，如有需要，請致電信興電工工程有限公司：28612767。

11. 售後服務

1. 由購買收據日期起之一年保修期內，經信興電器服務中心有限公司之服務人員證實產品故障屬正常使用下發生者，本公司將提供免費維修或更換零件服務。經更換之任何損壞零件，將歸屬本公司所有。保修範圍不包括修理或更換損耗性零件／配件如電源線、進水管、排水管、卡箍、三通、吸盤、量杯、機門、上／下噴水臂、上／下層盛載籃、平面過濾網、粗／幼過濾網及機殼等。如不當使用，或作為（半）商業用途，或未依照說明書使用，保修服務將無效，本公司將不會承擔任何損壞的維修責任及賠償。
2. 用戶必須於維修時出示購買／換購單據及蓋有銷售點／換購中心印章的產品保修記錄卡，如有任何疑問，請致電信興電器服務中心有限公司熱線查詢：24065666。

Thank you for choosing Rasonic table top dishwasher. Read the operation manual carefully before using and keep it for your future reference.

Table of Contents

1. Installation Guideline
2. Important Safeguards for Usage
3. Installation Method
4. Cleaning and Maintenance
5. Special Precautions
6. Product Specifications
7. Product Identification
8. Instructions for Use
9. Troubleshooting and Treatment
10. Special Avowal
11. After Sales Service

1. Installation Guideline

The appliance complies with current safety requirements. Inappropriate use may lead to personal injury and damage to property. When using the appliance, please follow the safety precautions as below:

To prevent fire, burn or electric shock
Before using the appliance

1. The appliance is a high power consumption electric appliance. Use an independent power source to supply. Do not connect with other high wattage appliances under the same socket, and make sure the input voltage match the rated voltage marked on the appliance.
2. The appliance must be earthed to avoid electric shock.
3. Ensure that the plug is plugged into the electric socket properly before use; otherwise, it will cause bad contact and overheat. The efficiency and effectiveness of the appliance will be affected or result in fire.
4. Net weight of the appliance is approximately 13 kg. Place the appliance on a level and rigid surface for use. This dishwasher having ventilation opening in the base. Avoiding placing the appliance near poor heat-resistant material such as carpet, plastic table cloth and cotton cloth, etc.
5. Place the appliance in a space with good ventilation. The product is intended to be used freestanding, do not placed it in a cabinet. Do not cover or block the steam exhaust vent to avoid overheating. Do not put any object on top of the appliance and do not insert metallic object (such as pins or wire) into the inside, gap and steam exhaust vent of the appliance.
6. Place the appliance in a well-ventilated and dry place. Keep it away from environment of corrosive gas, fire source, high temperature, strong electromagnetic, steam, humid oily or place close to flammable materials.

2. Important Safeguards for Usage

2.1 Before first use

1. Remove all packing materials from the appliance. If there is a protective plastic film wrapping the door, remove it beforehand.
2. Examine if there is crack(s) or damage on the appliance and accessories, for example the water tank, door, spray arms, upper/ lower basket and filters. Do not assembly and operate the appliance if any part is found damaged.
3. Moisture may be kept inside the water tank or body due to several mechanism tests performed by factory as to ensure proper functioning. Remove them by damp cloth.

2.2 Switch off the main power after use

1. After operation, unplug the appliance to avoid damaging to electronic elements, or even causing fire due to long-term connection to the electricity.
2. Keep the appliance clean. Pay attention to dust and moisture protection and protect the appliance against cockroaches and other insects from entering the water tank and steam exhaust vent to avoid short circuit.

2.3 Important safety instructions

1. To avoid damage, do not fill 40°C or above hot water into the water tank.
2. Use specific powder detergents for dishwasher use only. Do not use other easy-to foaming detergents to substitute such as liquid detergent, soap, laundry detergent, or liquid soap etc.; otherwise it may cause malfunction or dangerous. Keep children away from detergents. It may cause chemical burns in mouth, throat or eyes or as a result of suffocation. If accidentally splash into eyes, rinse immediately with water and seek medical treatment promptly.
3. Do not operate the dishwasher unless the door is properly in place. Do not open the door when the program is still running. There is a risk of hot water spraying out of the appliance.
4. To reduce the risk of injury, do not allow children to play inside or on the appliance, as remaining water in the washing chamber may contain detergent residue.
5. Do not lean or sit on the open door, body or baskets of the appliance; otherwise, the appliance could tip.
6. Danger of explosion! Do not add any solvent into the washing chamber.
7. Prevent sharp objects from scratching the rubber packing of the door and the body, to avoid the body rupturing, leakaging, and leading to electric shock hazard.
8. If door cannot be closed firmly; deformation or damage found on the door, stop operating the appliance immediately to avoid hazards. Contact Shun Hing Electric Service Centre Limited for checking and repairing.
9. Do not place any objects or allow dust or detergent residue accumulate between the body and the door.

2.4 Usage

1. Always keep the spray arms and filters clean to avoid affecting the rotation of the spray arm and cleaning performance. If the rotation of the spray arm is not smooth or the cleaning effect is not good, check if the spray arm and the filters are installed firmly. Disassemble the spray arms and filters, check if any residue blocking the outlet nozzle and waste water pump. Remove the obstacle and install all accessories immediately and clean the empty dishwasher by selecting <<PRE-WASH>> mode.

2. To prevent water overflowing from water tank inlet, do not fill water too quick. The appliance will automatically begin to drain excessive water to the cavity in advance. This is a normal operation. **CAUTION:** Excess water or filling rapidly will overflow the waste water pump and as a result of water leakage.
3. Do not fill water into the water tank when the appliance is in operation, otherwise, overflow or water leakage may happen.
4. Make sure all accessories (includes spray arms, cylinder filter and drain hose, etc.) are well installed before operation, otherwise, overflow or water leakage may happen due to high water pressure.
5. Sharp knives and objects are not recommended to be cleaned by the dishwasher. If necessary, knives and other utensils with sharp points must be placed properly. It avoids damaging the door rubber packing and to reduce the risk of cut-type injuries. **WARNING:** Knives or other sharp utensils with sharp points must be loaded in the basket pointing inside or placed in a horizontal position to avoid injury when picking up. Do not pass through cutlery basket to avoid blocking the operation of spray arm which causes damage.
6. Do not wash plastic items unless they are marked “dishwasher safe” or equivalent message. If no markings, consult with manufacturer’s recommendations.
7. Do not hit or strike the control panel as damage to controls or malfunction may occur.
8. Free-standing appliances may tip over if the baskets are overloaded, follow the instructions on **Chapter 6. Product Specification** to place dishware.
9. Do not store flammable materials on top or inside the appliance as it may cause fire. Never operate the appliance if accessories are not well installed.
10. The appliance is not intended to be operated by means of an external timer or separate remote-control system.
11. During operation and after use, the body, washing chamber and accessible parts may be extremely hot. Do not touch to avoid burns.
12. Beware of the force when opening the door, check whether the tableware is upset to avoid danger.
13. Do not use the appliance for purposes other than dishware cleaning, especially not to use the appliance to dry the clothes, paper products and other objects. (The appliance may cause malfunction if use it other than dishware cleaning.)
14. Never immerse the appliance, power cord and plug in water or let them wet, as to avoid functional damage to the appliance and electric shock.
15. Great care is necessary when using the power cord. Do not place heavy objects on the power cord and clip the power cord. Any modification is prohibited. Do not stretch or twist the power cord. Always hold the plug tightly with hands when unplugging or plugging in the socket.

16. After each use or when not using the appliance, make sure to unplug the appliance from the socket to prevent electric leakage and electric shock due to insulation degeneration. Do not touch, plug or unplug the appliance by wet hands which can result in electric shock. Do not hang the power cord over the edge of table, counter-top or contact with the hot surfaces.
17. Be sure to unplug the appliance and move, check or clean the appliance after cooling down.
18. The appliance is for household use only. Do not use it outdoors and in any other purpose or method which is not following the instructions in the user manual. If the appliance is used improperly, for commercial or semi-commercial use, your warranty becomes invalid and our company will refuse any liability and repairing cost for the damage caused.
19. Keep it out of reach for infants. Great care is necessary in using the appliance, especially near children. Make sure that they do not play with the appliance. Also, children without adult supervision should not operate the appliance and keep them away from the appliance.
20. The appliance can be used by children aged from 8 years and above and persons with reduced physical, sensory or mental capabilities, or lack of experience and knowledge, if they have given supervision or instruction concerning use of the appliance in a safe way and understand the hazards involved.
21. The appliance is intended to be used in household or similar environment such as staff kitchen areas in shops, offices and other working environments; by clients on hotels, motels and other residential type environments. Do not use it outdoors.
22. Always check the power cord, plug, door, spray arm, filters and baskets to ensure they are in good condition. To avoid hazards, stop operating the appliance immediately if any damaged or the appliance is dropped. Contact Shun Hing Electric Service Centre Limited for checking and repairing.
23. Do not use or attempt to replace any part or accessory which was produced without authorities, to avoid accidents. Otherwise the warranty becomes invalid.
24. In order to comply with safety regulations and avoid hazards, repair of electrical appliances must be carried by authorized technicians. If the appliance needs to be repaired, please present the official invoice, warranty registration card with the appliance for repair service and contact Shun Hing Electric Service Centre Limited, hotline at 2406 5666. (Address can be found at the back cover of the manual.)

3. Installation Method

Note! Install the appliance carefully according to the instructions. If it is not installed, tested or inspected in accordance with the manual, our company will refuse liability and repairing cost for the damage caused.

The using of water source of the appliance can be came from either manual water filling or fix water supply connection: for manual water filling, user can pour sufficient water into water tank directly; if fix water supply connection method is used, pay attention to the following:

- Once installation completed, trail test should be carried out and use it until it is properly checked.
- Do not use old water hose to avoid water leakage.
- The appliance has been tested during production. It is normal phenomenon if water residue is found inside the packaging materials.
- The rated inlet pressure of the appliance ranges from 0.04 MPa to 1.0 MPa. Make sure that the water pressure at the installation location is within the applicable range. When the water pressure is low, the operation time may be extended. If necessary, check with professionals before installation.

If fix water inlet installation is chosen, Users can follow the steps below to install:

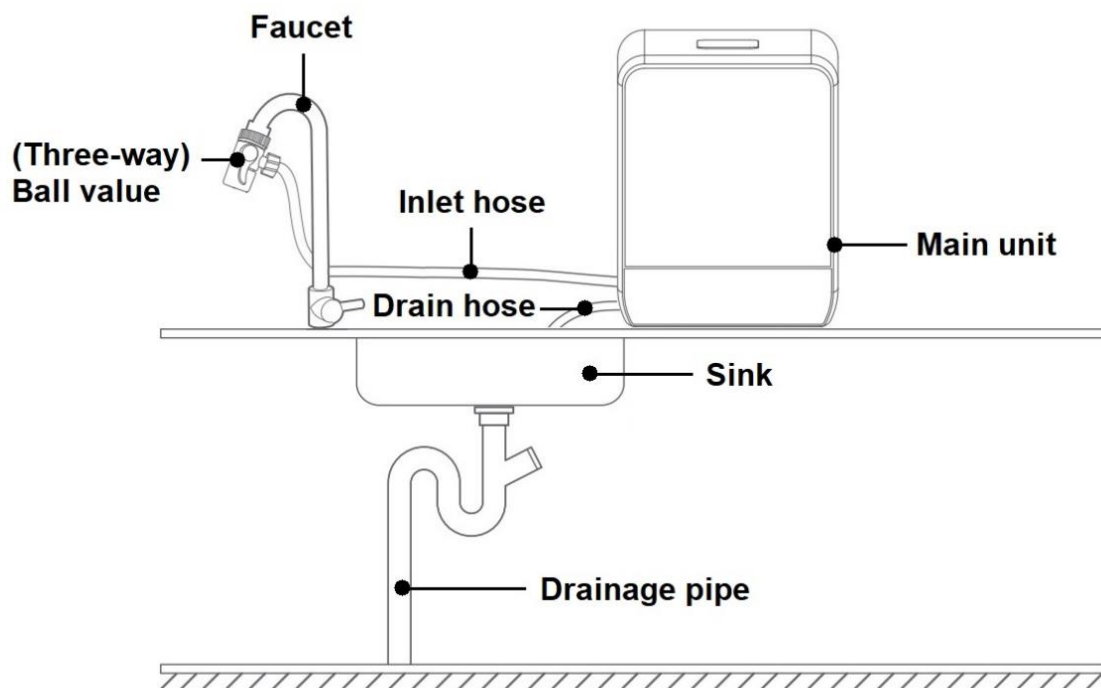

1. Turn off the water source: It must be confirmed that the water inlet system has been completely closed.

2. Installing the connection (three-way) ball valve

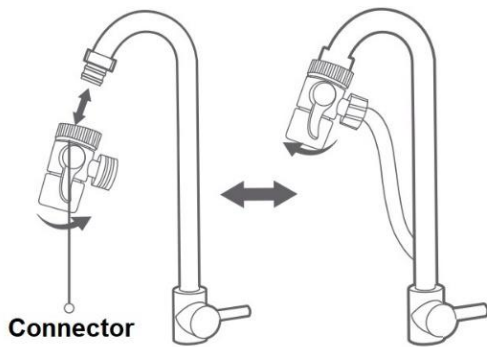

- As shown above, connect the connection ball valve to the faucet by rotating anti-clockwise direction. Then, connect the inlet hose (straight end) to the ball valve. The installation of ball valve is completed. To detach, close the faucet and disconnect the inlet hose, detach the ball valve by rotating in clockwise direction.

3. Connect the inlet hose

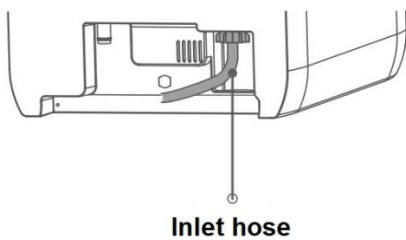

- Connect the other end of the inlet hose (bended end) to the water inlet at the back of the appliance.
- After the installation, faucet mode will be activated. Faucet indicator “” will be switched on when cleaning mode is selected. Water inflow from faucet directly to the appliance.

4. Connect the drain hose

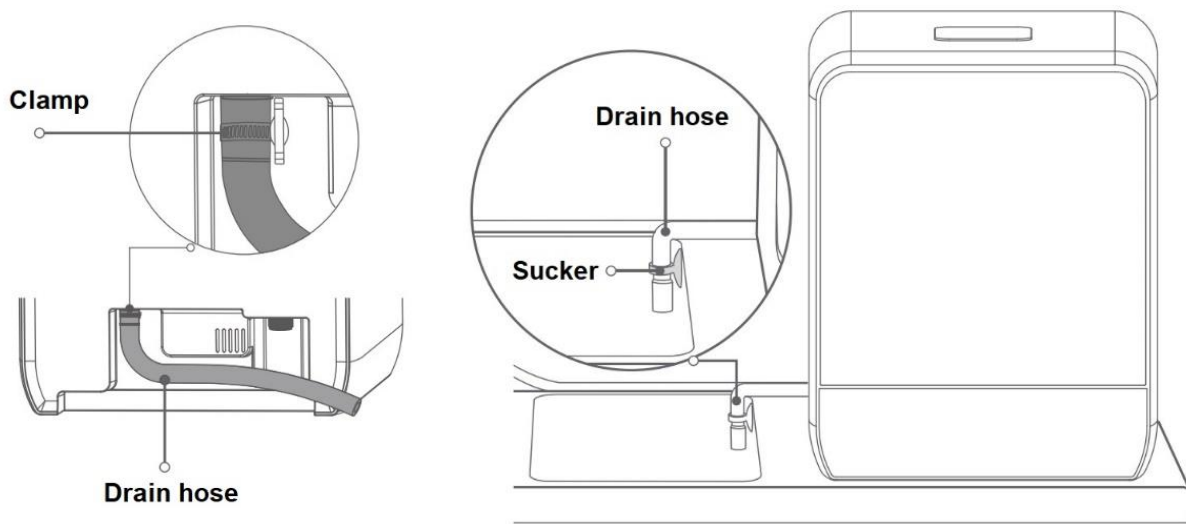

- Connect the one end the drain hose to the water outlet at the back of the appliance, and secure the hose by the use of clamp; then, place the other end of the drain hose to the sink by fixing the sucker.

4. Cleaning and Maintenance

Regular inspection and maintenance will help to prevent malfunction. Recommended to look for the following points to check,

1. Overall condition

Check if the spray arm deposited with grease and lime scale. If deposit found, add dishwasher detergent and start the “PRE-WASH” mode in an empty chamber

2. Clean the door and door seal

Clean door rubber packing with a damp cloth regularly. Never use steam cleaner to clean the dishwasher. We are not liable for any consequential damage if steam cleaner is used.

Regularly wipe the door and control panel with a damp cloth. Do not use sponges with a rough surface or abrasive detergents, as these could scratch the surfaces.

3. Filtration system

The entire filtration system consists of a coarse filter, a microfilter and a flat fine filter. The filtration system keeps large foreign objects or residues away from the circulation system. Clean them regularly to avoid affecting the performance of the appliance.

After each operation, check if any residue blocked by the filters and turn the cylinder filter anti-clockwise to unlock. Take out the cylinder filter together with flat fine filter, and clean them under running water. After that, turn the cylinder filter clockwise and ensure that the arrow marks are opposite to each other for proper installation.

4. Spray arm

Limescale and dirt in the rinsing water may block the nozzles or the bearing assemblies of the spray arms, and also obstruct the spray arm rotation. Check the outlet nozzles on the spray arms regularly. Clean the spray arm under running water and lock the spray arm into desired position. (Refer to **Chapter 7.2 Operation Instructions** for more details)

5. Waste water pump

Large food remnant, which is not being filtered by the filtration system, may block the waste water pump. Rinsing water will not be pumped out and as a result of blockage. In this case, switch off and disconnect the appliance from the power supply. Remove all the filters and remnants. Scoop out water, or make use of sponge if necessary. After cleaning process completed, reinstall all the filters before use.

6. Water inlet

The appliance is equipped with two water inlets where is on the top and at the back of the appliance, providing end user with two different channels to fill water into the appliance. Each inlet is equipped with a filter for water filtration. To prevent the water inlets from being obstructed and affecting the operation, make sure that those filters are cleaned regularly.

Preparation for Dishes and Tableware

1. If burnt stains or protein residue stick on tableware or dishes after baking, steaming egg or meats, user have to soak and preliminary cleanup before putting into dishwasher, otherwise the stains may not be cleaned completely.
2. If tableware or dishes remain obvious residues or the following residues, user have to cleanup preliminary: A. Granular or little residues as seasonings, spices or sesame; B. Foreign objects that might hinder spray arms rotation e.g. toothpaste, fish bones and rubber etc.; C. Residues that may cause odor e.g. fish skin and garlic etc.
3. If oily sauce or food coloring attached on dishes or tableware, rinsing first is recommended, otherwise oil or coloring may contaminate the interior of dishwasher.
4. Dishes or tableware that contaminated food coloring, tea stains or lipstick might not be cleaned completely.

General cleaning precautions

1. Never use other chlorinated household detergents! Health hazard!
2. Always unplug the appliance and let it cool down completely before cleaning.
3. Keep the body and door window clean. Do not use harsh abrasive cleaners or sharp metal scrapers to clean the door window since they can scratch the surface, which may result in shattering of the glass. (**Attention!** Do not let water penetrating to the gaps and steam exhaust vent when cleaning the appliance)
4. If the control panel gets wet, wipe it by soft and dry cloth. Do not use coarse and abrasive detergent to clean the control panel. When cleaning the control panel, open the door to prevent the appliance from accidentally turning on.
5. Do not use poisonous or corrosive detergent to clean the appliance.
6. Keep all cleaned parts dry thoroughly before install back to the appliance.
7. Allow the appliance to cool down completely and clean it before storage. Put it into a box and store in a dry place.
8. Never wrap the power cord tightly around the appliance or put any pressure on the power cord when storage as it could cause damage to the power cord.

5. Special Precautions

Make sure that the dishware or substance is suitable for dishwasher cleaning before operation. Following items are not suitable to be washed in the dishwasher,

1. Cutlery and utensils made of wood;
2. Delicate decorative glasses, craft and antique utensils;
3. Plastic items (unless they are marked “dishwasher safe” or equivalent; otherwise, consult with manufacturer’s advice);
4. Copper and tin utensils;
5. Utensils which are soiled with ash, wax, lubricating grease or ink, etc.;
6. Aluminum and silver parts (Tendency to discolor and fade after number of wash cycle);
7. Types of glass (e.g. crystal glass objects) (Tendency to turn cloudy after many wash cycle);
8. Utensils with anti-stick coating (unless they are marked “dishware safe” or equivalent; otherwise, consult with manufacturer’s advice);

6. Product Specifications Identification

Model no.	RDW-ZW39	
Color	White	
Rated Voltage	220–240V~ 50Hz	
Rated Water Pressure (Applicable to fix water supply connection)	0.04 MPa – 1.0 MPa	
Rated Power	950 – 1,050 W	
Water Tank Capacity (Approx.)	5L	
Net Weight (Approx.)	12.8 kg	
Product Dimension (W xD x H) (Approx.)	370 x 510 x 452 mm	
Recommended loading quantity and size available of dishware:	4.6-inch rice bowl x 6 6-inch soup bowl x 2 8-inch dish x 6 Condiment dish x 3	Glass cup/ Mug x 5 Soup/ rice ladle x 2 Spoon x 6 Chopstick x 6 pairs

7. Product Identification

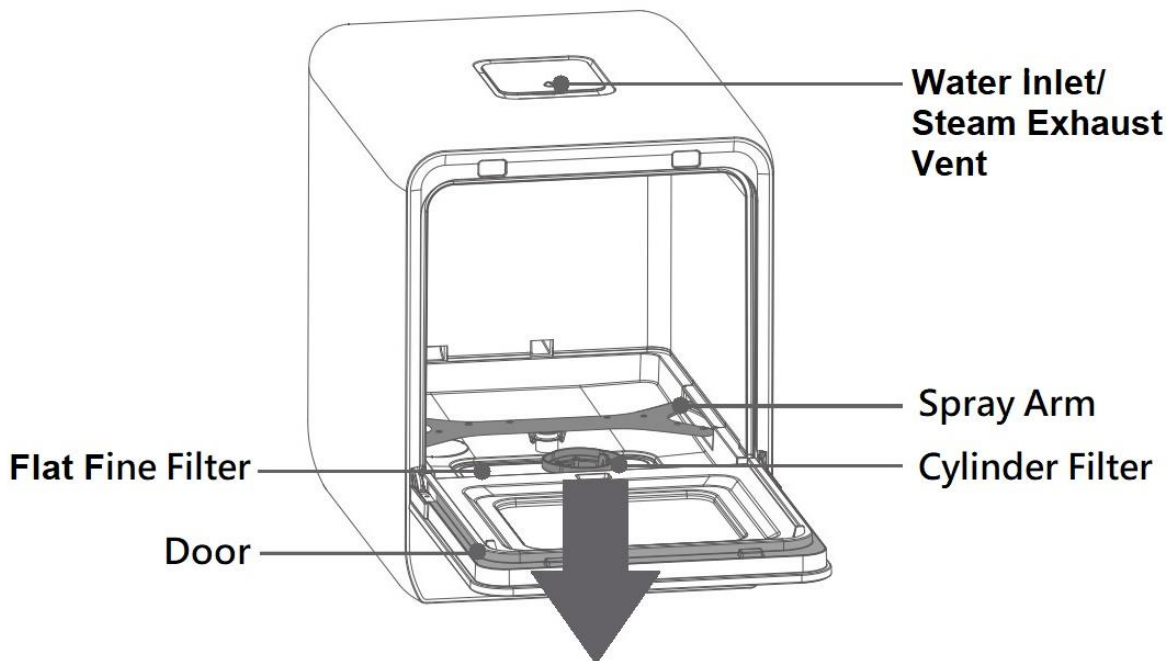

Coarse Filter



Microfilter

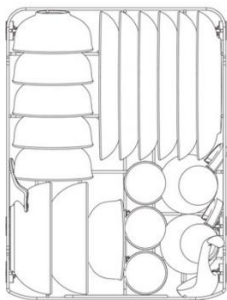

Lower Basket

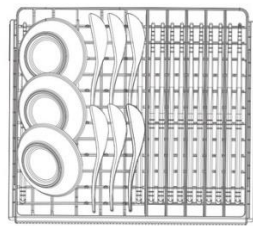

Upper Basket



Clamp



(Three-way)
Ball Valve



Sucker

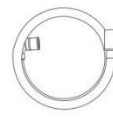

Drain Hose



Inlet Hose



Measuring Cup

7.1 Control Panel and Display

Control Panel



Display

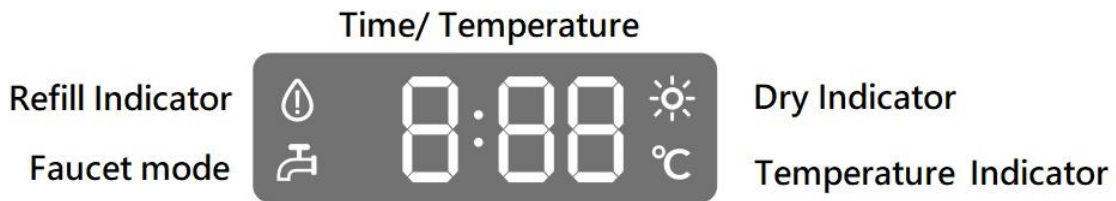

7.2 Operation Instructions (Applicable to manual water filling)

Attention! Prior to installation, disconnect the dishwasher from the power supply.

1. Refer to **Chapter 3. Installation Method**, direct the drain hose to the sink with sucker attached to prevent sewage flowing back. **CAUTION!** Keep the drain hose downward. If the hose is pointing upward, the maximum acceptable height is 15cm from the bottom of the appliance.

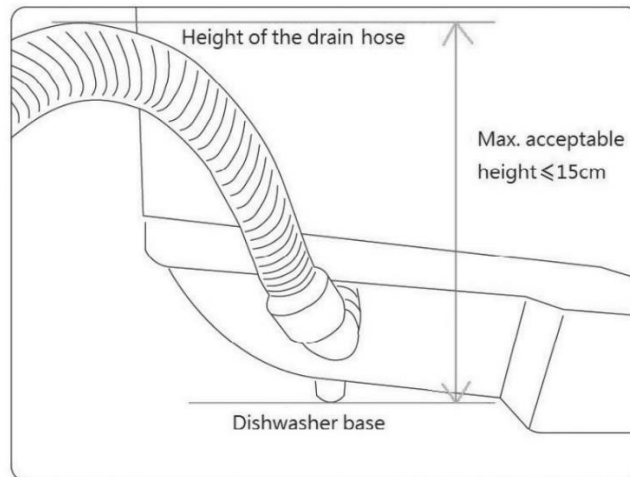

2. Remove all packing materials from the appliance. Install the flat fine filter and cylinder filter in order. (The cylinder filter is comprised of coarse filter and microfilter.) Turn the cylinder filter clockwise to lock in place.
3. Installation of spray arm: Hold the middle of the spray arm and align with the water supply outlet nozzle. Press down until it engages ("Click"). Spin the spray arm lightly and make sure it can rotate freely.
(Remarks: To ensure the appliance working properly, it is **NOT** recommended to detach the upper spray arm by yourself.)
4. Remove leftover food and sauce from the dishes by water flushing or by paper towel brushing, pull out the dishwasher basket and load the dishware and cutlery according to **Chapter 7.3 Prepare to load the Dishwasher**.

5. Push the basket into the washing chamber. Put moderated amount of dishwasher powder detergent in the powder grid (Max. 8g) of the door. Then close the door firmly.
6. Connect the power supply, the appliance will enter standby mode. Fill approx. 2.5 cups of measuring cup supplied to the water tank until “Ding Ding Ding” sound notice emitted representing that the tank is fully filled.

*** **ATTENTION!** Do not disassembly the round filter from the water tank opening.

*** Reserve enough space above for water filling.

*** If the water tank cannot be fully filled within 2 minutes, the appliance will return to standby mode automatically. Long press the **【POWER】** key for 3 seconds to switch on the appliance again.

*** If fixed water supply installation is used, please ignore this procedure. After water supply installation is fixed, faucet mode will be activated. Water will be injected from faucet automatically once cleaning mode is selected. Refer to **Chapter 3. Installation Method** for more details.

7. Long press the **【POWER】** key for 3 seconds to start the operation. Select the desired washing mode and press **【START/PAUSE】** key to confirm. If change of washing function is needed, long press the **【POWER】** key for 3 seconds to return to standby mode. Then, restart the appliance and select desired washing function again.
8. User is suggested to rinse the filters under running water after use immediately until most of the soils are removed to prevent bacterial growth. (If the soils are hard-to-remove, use a soft brush to clean. Do not use wire brush or scouring pad, otherwise, they may damage the filters.)
9. The appliance equipped with the ventilation function. It will be activated automatically when washing program finished, and dry indicator “☀” will light on accordingly. To cancel, long press the **【POWER】** key for 3 seconds and unplug the power plug.

7.3 Prepare to load the Dishwasher

Items should be loaded with soiled surface downward and in an upside sloping position to the spray as shown below. Do not load in opposite position. Chopstick and spoon should be placed on the upper basket. (Sharp items should be pointed inside to avoid injury.)

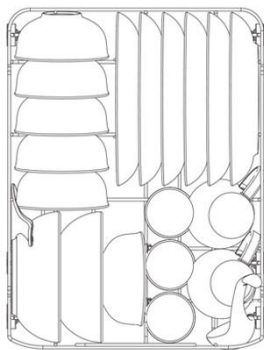

Lower Basket

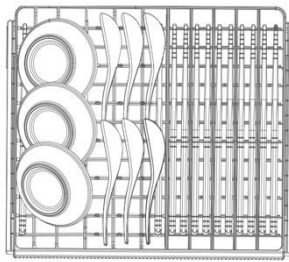

Upper Basket

For dishware, the opening should be placed slightly downward, and it should not be opened upwards or the bottom of the dishware upwards.

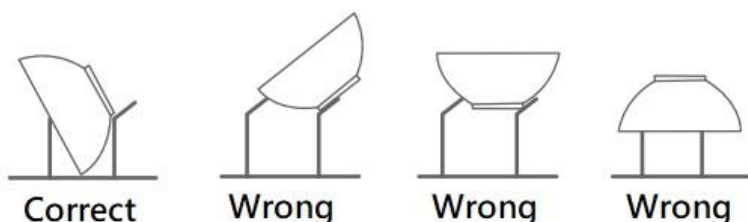

WARNING! Knife and other utensils with sharp points must be loaded in the basket pointing inside and placed in a horizontal position.







To avoid thumping noises during operation: avoid overlapping dishes. Make sure lightweight items are put inside the baskets securely.

CAUTION: Before the operation start, make sure all the dishes and cutlery are firmly placed in the baskets. If any dishware or cutlery passes through the baskets, it will affect the operation of the spray arm and stop the operation.

8. Instructions for Use

Once connect to the electricity, all indicators will flash once representing the appliance is in standby mode.

1. Power On: Long press the **【POWER】** key for 3 seconds to switch on the appliance. If no function is selected within 2 minutes, the appliance will automatically return to standby mode.
2. Function selection: Select desired washing function under standby mode, the appliance will start the operation by pressing the **【START/PAUSE】** key. Details of applications are as follow,

Washing Model	Icon	Washing Time (Approx.) [^]	Drying Time (Approx.)	Ventilation Mode	Remarks
NORMAL#		58 mins	60 mins	Auto start	8g dishwasher powder detergent suggested
ECO		88 mins	60 mins	Manual start (To activate, press 【Dry】 key once during the operation.)	8g dishwasher powder detergent suggested
INTENSIVE#		78 mins	60 mins	Auto start	8g dishwasher powder detergent suggested
INTENSIVE PLUS*#	/	98 mins	60 mins	Auto start	8g dishwasher powder detergent suggested
QUICK		28 mins	60 mins	Auto start	8g dishwasher powder detergent suggested
PRE-WASH		19 mins	N/A	N/A	NO dishwasher powder detergent required
DRY		N/A	60 mins	Auto start	NO dishwasher powder detergent required

[^]Remarks 1: Water filling and draining time are not included in washing time mentioned above, so the entire washing time would be longer. And, depends on the usage condition (e.g. the input water temperature, etc) the entire operating time may not be the same. The time shown in the above table are for reference only.

*Remarks 2: To select <<INTENSIVE PLUS>> washing mode, long press the **【INTENSIVE】** key for 3 seconds and display will show “1:38” (98 minutes) representing INTENSIVE PLUS washing mode is selected.

#Remarks 3: For <<NORMAL>>, <<INTENSIVE>> and <<INTENSIVE PLUS>> washing modes, the faucet mode (fixed water supply connection) will have one more rinsing procedure than the hand box mode (manual water filling), but the overall operation time remains unchanged.

3. Pause function: During operation, user can press the **【START/PAUSE】** key to suspend the washing program. Press the **【START/PAUSE】** key again to resume the operation.
4. Ventilation mode: To keep the dishware and washing chamber dry and away from odor generated, the appliance will enter the ventilation mode after washing operation completed (For <<ECO>> washing mode, you should enable the function **manually**). Duration of the mode last for 3 days in maximum, display will show “72H” (72 hours) while remaining time will show as descending order. To cancel, long press the **【POWER】** key for 3 seconds and the appliance will return to standby mode.
5. Extra ventilation mode: Depends on the situation, you can enable the extra ventilation function. Press the **【Dry】** key once when the washing program is operating, display will show “7d” (7 days) representing that extra ventilation mode is selected. The mode can last for 7 days in maximum, and remaining time will show as descending order. To cancel, press the **【Dry】** key once again and the appliance will return to “72H” ventilation mode.
6. Preset function (**NOT** applicable to DRY function): After selecting desired washing program, long press the **【Dry】** key for 5 seconds to enable the preset function. Default time 1 hour (“1H”) will be shown on display. Long press the **【Dry】** key for 5 seconds to preset the starting time of the washing program (Ranging from 1 hour/ 2 hours/ 3 hours/ 4 hours/ 5 hours/ 6 hours/ 8 hours/ 10 hours/ 12 hours/ 16 hours/ 20 hours/ 24 hours). Press the **【START/PAUSE】** key once to confirm.
7. Switch off: Unplug the appliance after finishing the operation.

9. Troubleshooting and Treatment

During operations, if any error occurred, please check the following table before calling for service. Below are common errors and points to check.

Problem/ Error code	Check points	Remedy
The interior, upper basket or under the fine filter are not dry enough	Dishware is dried properly?	If the dishware is dried properly, it is a normal phenomenon that small amount of residual water is remained in the interior, upper basket or under the fine filter of the appliance.

Dishware is not dried completely	Dishware is not loaded properly?	Refer “ Chapter 7.3 Prepare to load the Dishwasher ” to load the basket.
Dishware is not clean enough	Not enough powder detergent added?	Add sufficient dishwasher powder detergent.
	Dishware is not loaded properly?	Refer “ Chapter 7.3 Prepare to load the Dishwasher ” to load the basket.
	Filters are blocked by residue?	Refer to “ Chapter 4. Cleaning and Maintenance ” to clean the filters regularly.
	Incorrect washing program selected?	Depends on the situation and use a proper washing program.
Abnormal noise/ crash sound	Collision between dishware and spray arm?	Pause the operation, and check the loading condition of the dishware.
	Fallen of small objects?	Take out the small object dropped inside the interior. Avoid cleaning them by using the appliance next time.
No response after pressing function keys	Door is not closed properly?	Select washing program after closing the door.
	Door sensor failure	Contact Shun Hing Electric Service Centre Limited for checking and repairing.
Lots of foam generated in washing chamber	Other substances added apart from detergent?	Use the dishwasher powder detergent only.
Coloring of baskets	Dishware discolored	To avoid Dishware discolored, refer to “ Chapter 5. Special Precautions ” when loading.
Refill indicator is ON	Water tank is empty? (for Manual water filling)	Make sure to fill sufficient water before selecting washing program.

	Faucet is closed? Or, water pressure inputted below 0.04MPa? (for Fix water supply connection)	Make sure the faucet is opened, and make use of water pump if the water pressure inputted below 0.04MPa.
	Abnormal water inlet (for Fix water supply connection)	Straighten the inlet hose, make sure there is no excessive bend, fold or blockage of inlet hose.
	Abnormal water inlet	Contact Shun Hing Electric Service Centre Limited for checking and repairing.
Error code	E1 Abnormal water inlet	Make sure the faucet is opened, and restart the operation. If the situation continues, Contact Shun Hing Electric Service Centre Limited for checking and repairing.
	E2 Abnormal water drainage	Close the faucet, contact Shun Hing Electric Service Centre Limited for checking and repairing.
	E3 Overflowing	Contact Shun Hing Electric Service Centre Limited for checking and repairing.
	E4 Water temperature sensor failure	Contact Shun Hing Electric Service Centre Limited for checking and repairing.
	E5 Communication failure	Contact Shun Hing Electric Service Centre Limited for checking and repairing.
	E6 Heater failure	Cut off the electricity and restart. If the situation continues, Contact Shun Hing Electric Service Centre Limited for checking and repairing.
	E7 Ventilation fan failure	Contact Shun Hing Electric Service Centre Limited for checking and repairing.

If the above solutions cannot fix the problem, stop using the appliance immediately and contact Shun Hing Electric Service Centre Ltd. to check and repair.

9. Special Avowal

1. The content in the manual has been checked. Our company reserves the hermeneutic power to any printing errors or misunderstanding on the content.
2. If there are technical improvements on the appliance, the operation manual will be updated in new version without prior notice. The product appearance and specification are subject to the manufacturer information.
3. In case there is any inconsistency or conflict between the English versions and Chinese versions of the terms, the Chinese versions shall prevail.
4. The e-copy of user manual can be sent by email on request. For enquiry, please call Shun Hing Electric Works and Engineering Co., Ltd. at 2861 2767.

11. After Sales Service

1. For any defect, in the judgment of technician from Shun Hing Electric Service Centre Limited, caused under normal use, our company is responsible for repairing or replacing any parts of the said electrical appliance free of charge within one year guarantee period commencing from the date of purchase. Any defective part which has been replaced shall become our property. Warranty service does not cover the repair or replacement of consumable parts such as power cord, inlet hose, drain hose, clamp, ball valve, sucker, measuring cup, door, upper/ lower spray arms, upper/ lower baskets, flat fine filter, coarse filter/microfilter and enclosure, etc. If the appliance is used improperly, for commercial or semi-commercial use, or not following the instructions in the operation manual, the warranty becomes invalid and our company will refuse any liability and repairing cost for the damage caused.
2. User must present the official invoice/redemption voucher and the product warranty card with the chop from sales point/redemption center for maintenance. For enquiries, please call Shun Hing Electric Service Centre Limited hotline at 2406 5666.

備忘錄

備忘錄



SHUN HING GROUP
信興集團
SINCE 1953

Rasonic 樂信牌

信興電工工程有限公司

SHUN HING ELECTRIC WORKS AND ENGINEERING CO., LTD.

辦公室：香港九龍尖沙咀東部麼地道 67 號半島中心 9 樓

電話：2861 2767

圖文傳真：2865 6706

網址：<http://www.rasonic.com>

電郵：shew@shunhinggroup.com

Office: 9/F, Peninsula Centre, 67 Mody Road, Tsimshatsui East, Kowloon, Hong Kong

Tel: 2861 2767

Fax: 2865 6706

Website: <http://www.rasonic.com>

E-mail: shew@shunhinggroup.com

保養及維修 Maintenance and Repair Service:

信興電器服務中心有限公司

SHUN HING ELECTRIC SERVICE CENTRE LTD.

香港新界葵涌勝耀街 2 號信興中心 11 樓

電話：2406 5666

圖文傳真：2408 0316

網址：<https://www.shunhing-service.com/zh>

11/F, Shun Hing Centre, 2 Shing Yiu Street, Kwai Chung, N.T. HK

Tel: 2406 5666

Fax: 2408 0316

Website: <https://www.shunhing-service.com/en>

客戶服務中心：

香港新界葵涌勝耀街2號信興中心1樓

九龍尖沙咀東部麼地道67號半島中心B座9樓

香港天后琉璃街7號柏景中心22樓

澳門慕拉士大馬路193-199號南嶺工業大廈5樓I座

Customer Service Centre

1/F, Shun Hing Centre, 2 Shing Yiu Street, Kwai Chung, N.T.

9/F., Block B, Peninsula Centre, 67 Mody Road, Tsim Sha Tsui East, Kowloon

22/F, Parkview Centre, 7 Lau Li Street, Tin Hau, Hong Kong

Avenida de Venceslau de Morais, No. 193-199, 5 andar - I, Edf. Industrial Nam Leng, Macau

有關最新之香港及澳門客戶服務中心資料，請參閱信興服務中心網址：<https://www.shunhing-service.com/zh>

For the latest information of Hong Kong and Macau service center, please visit: <https://www.shunhing-service.com/en>

RDW-Z0824